

Table of Contents

PRODUCT	PRODUCT CODE	TECHNICAL INSTRUCTIONS	PAGE #
Pneumatic Room Thermostats—Powerstar			
Overview/Selection Guide			A-3
Single Setpoint Room Thermostats	TH 192S	155-065P25	A-5
Heating/Cooling Room Thermostats	TH 192/4HC	155-066P25	A-7
Day/Night and Day/Night/Vent Room Thermostats	TH 192/4DN/DNV	155-067P25	A-9
Free Energy Band Heating/Cooling Room Thermostats	TH 193HC	155-068P25	A-11
(Hesitation) Free Energy Band Heating/Cooling Room Thermostats	TH 193HC	155-069P25	A-13
Retroline® Retrostat Room Thermostats	TH 192/4	—	A-15
Pneumatic Room Thermostats—D Series			
Room Thermostats	TH 832D	155-072P25	A-19
Pneumatic Thermostats for Specialized Applications			
Limitem Rigid Bulb Thermostats	TH 356	155-070P25	A-21
Limitem Remote Bulb Thermostats	TH 357	155-071P25	A-23
Unit Mounted Thermostats	TH 188	155-064P25	A-25
High and Low Temperature Detection Thermostats	TH 134	155-063P25	A-27
Electric Room Thermostats/Controllers			
Line Voltage Remote Bulb Thermostats	ET 141	155-019P25	A-29
Line Voltage Room Thermostats—Heating/Cooling	ET 134	155-017P25	A-31
Room Thermostats	RAA...	155-519P25	A-33
Fan Coil Thermostats	RAB...	155-524/526/528P25	A-37
Room Temperature Controllers for Two-pipe Fan Coil Units	RCC...	155-712/713/323	A-41
Free Energy Band Room Temperature Controllers for Four-pipe Fan Coil Units	RCC...	155-324	A-43
Room Temperature Controllers for CAV Systems	RCU15/50...	155-327P25	A-47

(Continued on next page)

Standard Shipping within 3 to 5 days Products ordered through the Rapid Response™ program can ship same day. Expect longer lead times for large quantities and unique parts. See inside back cover for details on Rapid Response™ shipping.

Table of Contents *(Continued)*

PRODUCT	PRODUCT CODE	TECHNICAL INSTRUCTIONS	PAGE #
Electric Room Thermostats/Controllers (continued)			
Room Temperature Controllers for CAV and VAV Systems	RCU61	155-328P25	A-51
Room Temperature Controller with Two 0 to 10 Vdc Outputs	RLA162.5U	155-515	A-55
Room Temperature Controllers with LCD for Heating and Cooling Systems	RDU...	155-735	A-59
Room Temperature Controllers with LCD	RDX...	155-747	A-63
Room Temperature Controllers with LCD for Two-Pipe Fan Coil Units	RDF...	155-333/334/335/336	A-67
Electric Thermostats for Specialized Applications			
Surface Mounted/High Temperature Limit Control Thermostats	ET 141	155-021P25	A-71
Low Temperature Detection Thermostats	ET 134	155-016P25	A-73
Accessories and Service Kits			A-75

A-2

Thermostats

Powerstar Room Thermostats

Proven to provide fast response and highly accurate temperature control, Powerstar Pneumatic Room Thermostats are designed to control heating and/or cooling by operating a variety of pneumatic devices such as valves or damper actuators.

Powerstar thermostats are factory calibrated to control pneumatic devices over a 3 to 15 psi (103 to 207 kPa) range.

Powerstar pneumatic room thermostats are available for the following applications:

- Single Temperature
- Day/Night
- Day/Night/Vent
- Heating/Cooling
- Free Energy Band
- Free Energy Band with Hesitation

Covers are available with concealed or exposed setpoint adjustment, room temperature indication, and setpoint indicator.



Selection Guide

Air Supply	Applications	Control Outputs	Control Setpoints	Control Actions	Air Output Capacity		Model
					Low (1-pipe)	High (2-pipe)	
15 to 30 psi (103 to 207 kPa)	• Heat or Cool	Single	Single	Direct/Reverse	•	•	192 S
Cool 18 psi (124 kPa) Heat 25 psi (172 kPa)	• Heat and Cool (auto changeover) • Factory calibrated (194 HC) for Honeywell or Johnson retrofit	Single	Dual	Direct/Direct		•	192 HC
				Reverse/Reverse		•	194 HC
				Direct/Reverse		•	
				Reverse/Direct		•	
Day 18 psi (124 kPa) Night 25 psi (172 kPa)	• Day and Night (auto changeover) • Factory calibrated (194 DN) for Honeywell or Johnson retrofit • R2 vent ("0") day, full supply night (DNV only, 3-pipe) • Night override selector switch	Single	Dual (Day/Night)	Direct/Direct		•	192 DN
				Reverse/Reverse		•	194 DN
Day 18 psi (124 kPa) Night 25 psi (172 kPa)	• Day and Night (auto changeover) • Factory calibrated (194 DN for Honeywell or Johnson retrofit) • R2 vent ("0") day, full supply night (DNV only, 3-pipes) • Night override selector switch	Dual	Dual (Day/Night with Vent)	None	•	•	192 DNV 194 DNV
15 to 30 psi (103 to 207 kPa)	• Heat and Cool • Sequence-controlled devices with two control lines (same or different range)	Dual	Dual (Heat/Cool)	Direct/Direct	•	•	193 HC Free Energy Band
				Reverse/Reverse	•	•	
				Direct/Reverse	•	•	
				Reverse/Direct	•	•	
15 to 30 psi (103 to 207 kPa)	• Heat and Cool • Sequence-controlled devices with one control line (different spring ranges)	Single	Dual (Heat/Cool)	Direct/Direct		•	193 HC Free Energy Band (Hesitation)

Housings with No Logo Option

Our award-winning housing design, plus a variety of energy-saving functions and adaptability options, make Siemens thermostats a welcome addition to any room. Look for the “No Logo” cover option to inconspicuously enhance a room’s aesthetics.



Powerstar Single Setpoint Pneumatic Room Thermostat

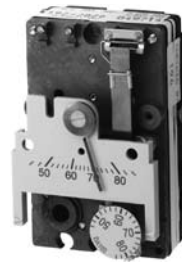

192 S Thermostat chassis.



Typical wall plate and screws.

Description

Providing proportional single output, single setpoint, 1-pipe for low air capacity or 2-pipe for high air capacity pneumatic room temperature control, the 192 S Powerstar Single Setpoint Pneumatic Room Thermostat is the most economical model. Refer to the Retroline® Retrostats on page A-15 to replace competitive models.

Features

- Single setpoint dial available in Fahrenheit or Celsius scales
- Available in direct or reverse acting models
- Sensitive bimetal responds to temperature changes
- Integral, field adjustable limit stops
- Wall mounting plate for connection to a variety of rough-in terminal boxes included
- Large volume air capacity relay in 2-pipe models only
- Test port for fast check of output pressure without removing the cover
- Field replaceable thermometer, setpoint dial, restrictor and filters for decreased maintenance cost

Options

- Quick-connect air connections for ease of installation and service
- Fixed limit stops to meet government specifications
- Large, 1/2" setpoint knob for convalescent homes

Applications

Designed for heating and cooling applications for control of pneumatic valves and damper actuators. The 192 S Powerstar Single Setpoint Pneumatic Room Thermostat is excellent for commercial and institutional facilities.

Recommendation

1-pipe: Use when limited output air capacity is required to operate a single valve and/or actuator; requires external restrictor, 20 scim (5.4 ml/s) air supply.

2-pipe: Use for high output capacity for control of multiple valves and actuators, used with or without high/low limiting controls.

Application Drawings

Dotted lines are alternative control schemes.

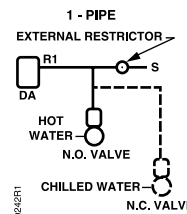

DIAGRAM 1.

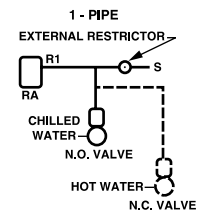

DIAGRAM 2.

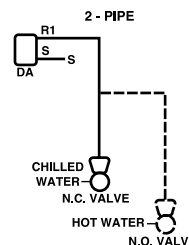

DIAGRAM 3.

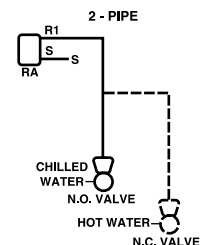

DIAGRAM 4.

192 S Thermostat Specifications

▶ For complete conversion kits, refer to the Retroline® Retrostats starting on page A-15.

- Scale; Range**
 Major (minor) Divisions..... 45 to 85°F, 10(2)°F
 (7 to 30°C, 5(1)°C)
- Factory Calibration** 72°F, 7.5 psi ±0.3
 (22°C, 52 kPa @ 1.8)
- Sensitivity Adjustment Range** 1 to 4 psi/°F (12 to 50 kPa/°C)
- Factory Setting** 2.5 psi/°F (31 kPa/°C)
- Limit Stop**
 Field Adjustment Range 45/85°F (7/30°C)
 Fixed Limit Stop Range 55/75°F (13/24°C)
- Temperature**
 Storage..... -10 to +140°F (-23 to +60°C)
 Ambient Operating 40 to 140°F (4 to 60°C)
- Accuracy at Factory**
 Calibration ±2°F (±1.1°C)
 Response 0.1°F (0.06°C)
- Supply Air Pressure**
 Recommended..... 25 psi (172 kPa)
 Maximum..... 30 psi (207 kPa)

- Nominal Air Consumption for Air Compressor Sizing**
 1-pipe 25 scim (6.8 ml/s)
 2-pipe 20 scim (5.5 ml/s)
- Nominal Air Capacity for Air Main Sizing**
 1-pipe 25 scim (6.8 ml/s)
 2-pipe 20 scim (5.5 ml/s)
- Nominal Chassis Air Capacity**
 1-pipe Supply 25 scim (6.8 ml/s)
 2-pipe Supply 230 scim (63 ml/s)
 1-pipe Exhaust 30 scim (8 ml/s)
 2-pipe Exhaust 150 scim (41 ml/s)
- Air Connections** 5/32" (4 mm) OD tubing
- Dimensions (with cover)** 2.16" W x 3.34" H x 1.59" D
 (55 mm W x 85 mm H x 40 mm D)
- Shipping Weights (with cover)**
 Thermostat Chassis and Wall Plate 0.53 lb. (0.24 kg)
 Plastic Cover/Metal Cover 0.07 lb. (0.04 kg)/0.27 lb. (0.12 kg)

192 S Thermostat Product Ordering

Model #	Thermostat Chassis Type				Thermostat Chassis & Wall Plate	
	Output	Setpoint	Air Output Capacity	Thermometer & Setpoint Scales	Control Action	
					Direct	Reverse
192 S 1-pipe	Single	Single (Heat or Cool)	Low (No Relay)	°F °C	192-200	192-201
					192-220	192-221
192 S 2-pipe	Single	Single (Heat or Cool)	High (Integral Relay)	°F °C	192-202	192-203
					192-222	192-223

Chassis Options: Chassis with 1/2" (13 mm) diameter setpoint adjustment knob for convalescent facilities. Available in Desert Beige only. Add a "K" to the end of the Part No., for example **192-200K**.



Thermostat Covers (Sold Separately)	Plastic Part No.		Metal Part No.
	Desert Beige	White	
<ul style="list-style-type: none"> • Adjustment setpoint concealed • Indicator setpoint concealed • Chassis thermometer concealed • No logo 	192-257	192-257W	192-357
<ul style="list-style-type: none"> • Adjustment setpoint concealed • Indicator setpoint concealed • Chassis thermometer concealed • With logo 	192-256	192-256W	192-356
<ul style="list-style-type: none"> • Adjustment setpoint concealed • Indicator setpoint concealed • Chassis thermometer exposed 	192-254	192-254W	192-354
<ul style="list-style-type: none"> • Adjustment setpoint key • Indicator setpoint exposed • Chassis thermometer concealed • Use with 1/2" setpoint knob option 	192-265	192-265W	192-365
<ul style="list-style-type: none"> • Adjustment setpoint key • Indicator setpoint exposed • Chassis thermometer exposed • Use with 1/2" setpoint knob option 	192-266	192-266W	192-366
<ul style="list-style-type: none"> • Adjustment setpoint exposed • Indicator setpoint exposed • Chassis thermometer concealed 	192-250	192-250W	192-350
<ul style="list-style-type: none"> • Adjustment setpoint exposed • Indicator setpoint exposed • Chassis thermometer concealed 	192-252	192-252W	192-352

Note: • "Exposed features" are indicated in green on corresponding illustration.
 • Universal Cover sold on page A-83. For 194 refer to Powerstar Retroline section.



Part No. in black box Ships same day when requested through Rapid Response™ shipping. See inside back cover for details.

SIEMENS

Powerstar Heating/Cooling Pneumatic Room Thermostats

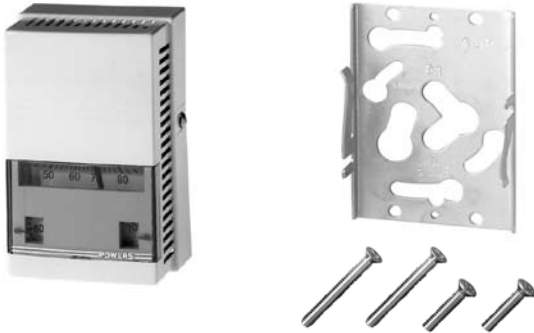

192 HC Thermostat chassis.

Typical wall plate and screws.



192 HC Thermostat with plastic cover. Chassis wall plate with easy maintenance plug-in adapters shown (optional).

Description

Providing proportional single output, dual setpoint with 2-pipe for high air capacity pneumatic room temperature control, the 192 HC Powerstar Heating/Cooling Pneumatic Room Thermostat provides two thermostats under one cover; one side for heating and the other for cooling. Switchover is accomplished by changing the air pressure to the thermostat.

Features

- Dual setpoint dial available in Fahrenheit or Celsius scales
- Available in direct or reverse acting models
- Sensitive bimetal responds to temperature changes
- Integral, field adjustable limit stops
- Adjustable changeover pressure
- Large volume air capacity relay
- Wall mounting plates provides connection to a variety of rough-in terminal boxes
- Test port for fast check of output pressure without removing the cover
- Field replaceable thermometer, setpoint dials, restrictor and filters

Options

- Fixed limit stops to meet government specifications
- Quick-connect air connections for ease of installation and service
- Large, 1/2" setpoint knob for convalescent homes

Applications

Designed for temperature control of heating and cooling applications, the 192 HC Powerstar Heating/Cooling Pneumatic Room Thermostat controls valves and damper actuators in cooling equipment. Providing energy management and occupant comfort, the thermostat automatically adjusts to seasonal changes from heating setpoint to cooling setpoint in commercial and institutional facilities.

Recommendation

For control of multiple valves and actuators, use with or without high/low limiting controls.

Application Drawing

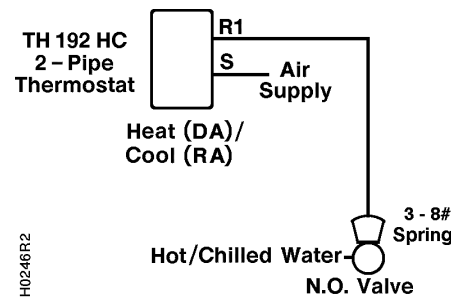

192 HC Thermostat Specifications

▶ For complete conversion kits, refer to the Retroline® Retrostats starting on page A-15.

Scale; Range
Major (minor) Divisions.....45 to 85°F, 10(2)°F
(7 to 30°C, 5(1)°C)

Factory Calibration 72°F, 7.5 psi ± 0.3
(22°C, 52 kPa @ 1.8)

Sensitivity Adjustment Range 1 to 4 psi/°F (12 to 50 kPa/°C)

Factory Setting 2.5 psi/°F (31 kPa/°C)

Limit Stop
Field Adjustment Range45/85°F (7/30°C)
Fixed Limit Stop Range.....55/75°F (3/24°C)

Temperature
Storage.....-10 to +140°F (-23 to +60°C)
Ambient Operating40 to 140°F (4 to 60°C)

Accuracy at Factory
Calibration±2°F (±1.1°C)
Response0.1°F (0.06°C)

Supply Air Pressure
Two Pressure (Recommended) Cooling/Heating..... 18 psi (124kPa)/
(124 kPa)/25 psi (172 kPa)

Supply Air Pressure
Two Pressure (Range)
Cooling 15 to 19 psi (103 to 131 kPa)
Heating 23 to 30 psi (159 to 207 kPa)

Two Pressure, Honeywell Competitive Model
Cooling/Heating 13 psi (90 kPa)/18 psi (124 kPa)

Two Pressure, Johnson Competitive Model¹
Cooling/Heating 15 psi (103 kPa)/20 psi (138 kPa)

Nominal Air Consum. for Air Compressor Sizing25 scim (6.8 ml/s)

Nominal Air Capacity for Air Main Sizing40 scim (11 ml/s)

Nominal Air Capacity
Supply/Chassis Exhaust..... 150 scim (41 ml/s)/150 scim (41 ml/s)

Air Connections5/32" (4 mm) OD tube

Dimensions (with cover) 2.16" W x 3.34" H x 1.59" D
(55 mm W x 85 mm H x 40 mm D)







Shipping Weights
Thermostat Chassis and Wall Plate 0.53 lb. (0.24 kg)
Plastic Cover0.07 lb. (0.04 kg)
Metal Cover (single/dual) 0.27 lb. (0.12 kg)/0.7 lb. (0.3 kg)

1. Some Johnson Controls heat/cool thermostats have a cooling supply pressure of 20 psi (138 kPa) and a heating supply pressure of 15 psi (103 kPa). For this application, the heating and cooling actions must be reversed. If exposed setpoint is required, order special cover, **192-773**.

192 HC Thermostat Product Ordering

Model #	Thermostat Chassis Type				Thermostat Chassis & Wall Plate	
	Output	Setpoint	Air Output Capacity	Thermometer & Setpoint Scales	Control Action	
					Heat Direct	Heat Reverse
192 HC 2-pipe	Single	Dual (Heat and Cool)	High (Integral Relay)	°F	192-207 Cool (DA)	192-209 Cool (DA)
				°F	192-208 Cool (RA)	192-210 Cool (RA)
				°C	192-227 Cool (DA)	192-229 Cool (DA)
				°C	192-228 Cool (RA)	192-230 Cool (RA)

Chassis Options: Chassis with 1/2" (13 mm) diameter setpoint adjustment knob for convalescent facilities. Available in Desert Beige only. Add a "K" to the end of the Part No., for example **192-207K**.

Thermostat Covers (Sold Separately)	Plastic Part No.		Metal Part No.
	Desert Beige	White	
 <ul style="list-style-type: none"> • Adjustment setpoint concealed • Indicator setpoint concealed • Chassis thermometer concealed • No logo 	192-257	192-257W	192-357
 <ul style="list-style-type: none"> • Adjustment setpoint concealed • Indicator setpoint concealed • Chassis thermometer concealed • With logo 	192-256	192-256W	192-356
 <ul style="list-style-type: none"> • Adjustment setpoint concealed • Indicator setpoint concealed • Chassis thermometer exposed 	192-254	192-254W	192-354
 <ul style="list-style-type: none"> • Adjustment setpoint key • Indicator setpoint exposed • Chassis thermometer concealed 	192-267	192-267W	192-367
 <ul style="list-style-type: none"> • Adjustment setpoint key • Indicator setpoint exposed • Chassis thermometer exposed • Use with 1/2" setpoint knob option 	192-268	192-268W	192-368
 <ul style="list-style-type: none"> • Adjustment setpoint exposed • Indicator setpoint exposed • Chassis thermometer concealed • Use with 1/2" setpoint knob option 	192-258	192-258W	192-358
 <ul style="list-style-type: none"> • Adjustment setpoint exposed • Indicator setpoint exposed • Chassis thermometer concealed 	192-260	192-260W	192-360

Note: • "Exposed features" are indicated in green on corresponding illustration.
• Universal Cover sold on page A-83.



Part No. in black box Ships same day when requested through Rapid Response™ shipping. See inside back cover for details.

SIEMENS

Powerstar Day/Night/Vent Pneumatic Room Thermostats

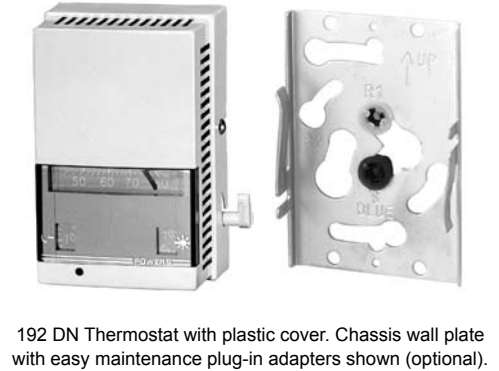
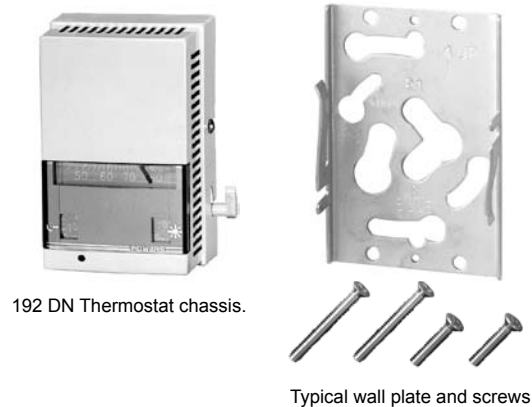

Description

Providing proportional dual setpoint, 2-pipe or 3-pipe high air capacity pneumatic room temperature control, the 192 DN or DNV Powerstar Pneumatic Room Thermostat automatically resets the room temperature setpoint during unoccupied hours by changing the air pressure to the thermostat. A manual override feature allows occupants to switch to day mode. The override returns to night mode the following night.

Features

- Dual setpoint dial available in Fahrenheit or Celsius scales
- Available in direct or reverse acting models
- Sensitive bimetal responds to temperature changes
- Manual override selector for off-hour occupant comfort
- Adjustable changeover pressure
- Large volume air capacity relay
- Integral, field adjustable limit stops
- Wall mounting plate for connection to a variety of rough-in terminal boxes included
- Test port for fast check of output pressure without removing the cover
- Field replaceable thermometer, setpoint dial, restrictor and filters

Options

- Fixed limit stops to meet government specifications
- Quick-connect air connections for ease of installation and service
- Large, 1/2" setpoint knob for convalescent homes

Applications

The 192 DN and DNV Powerstar Pneumatic Room Thermostat controls valves and damper actuators in cooling equipment, automatically performing setback changes from day to night. The 192 DNV also performs a purge sequence at night to bring in "vent" outside air to cool the building. A manual override selector switch allows individual room or zone "day" control locally during the night cycle.

During the night control cycle, the 192 DNV models provide a separate output signal (full air supply) allowing ventilation control. Periodic resetting to the "night" control mode during evening or weekend periods using time clocks ensures optimal energy management.

Recommendation

Use 192 DN or DNV for multiple valves and actuators, with or without high/low limiting controls.

Application Drawings

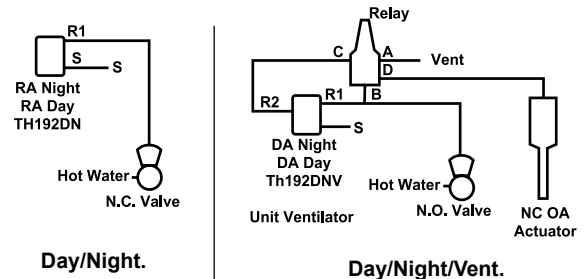

Chassis Port R2 Pressure	Operation Mode (Air Supply)	Switching Relay Connection
Full Air Supply	Night (S=25 psi)	A-D
0 psi	Night Occupied	B-D
0 psi	Day (S=18 psi)	B-D

192 DN/DNV Thermostat Specifications



For complete conversion kits, refer to the Retroline® Retrostats starting on page A-15.





- Scale; Range**
Major (minor) Divisions..... 45 to 85°F, 10(2)°F
(7 to 30°C, 5(1)°C)
- Factory Calibration**72°F, 7.5 psi
(22°C, 31 kPa)
- Sensitivity Adjustment Range** 1 to 4 psi/°F (12 to 50 kPa/°C)
- Factory Setting** 2.5 psi/°F (31 kPa/°C)
- Limit Stop**
Field Adjustment Range 45/85°F (7/30°C)
Fixed Limit Stop Range..... 55/75°F (3/24°C)
- Temperature**
Storage..... -10 to +140°F (-23 to +60°C)
Ambient Operating 40 to 140°F (4 to 60°C)
- Accuracy at Factory**
Calibration ±2°F (±1.1°C)
Response 0.1°F (0.06°C)
- Supply Air Pressure**
Two Pressure
Day (recommended)..... 18 psi (124 kPa)
Night (recommended)..... 25 psi (172 kPa)
Vent-Day/Night 0 psi (0 kPa)/25 psi (172 kPa)

- Two Pressure
Day (range)..... 15 to 19 psi (103 to 131 kPa)
Night (range)..... 23 to 30 psi (159 to 207 kPa)
- Two Pressure (Honeywell Competitive Model)
Day/Night..... 13 psi (90 kPa)/18 psi (124 kPa)
- Two Pressure (Johnson Controls Competitive Model)
Day/Night..... 15 psi (103 kPa)/20 psi (138 kPa)
- Nominal Air Consumption for Air Compressor Sizing** 25 scim (6.8 ml/s)
- Nominal Air Capacity for Air Main Sizing** 40 scim (11 ml/s)
- Nominal Chassis Air Capacity**
Supply 230 scim (63 ml/s)
Exhaust 150 scim (41 ml/s)
- Air Connections** 5/32" (4 mm) OD tube
- Dimensions (with cover)**
192 DN 2.16" W x 3.34" H x 1.59" D
(55 mm W x 85 mm H x 40 mm D)
192 DNV 2.5" W x 3.34" H x 1.59" D
(64 mm W x 85 mm H x 40 mm D)
- Shipping Weights**
Thermostat Chassis and Wall Plate 0.53 lb. (0.24 kg)
Plastic Cover 0.07 lb. (0.04 kg)
Metal Cover (dual)..... 0.27 lb. (0.12 kg)

192 DN/DNV Thermostat Product Ordering

Model #	Thermostat Chassis Type				Thermostat Chassis & Wall Plate		
	Output	Setpoint	Air Output Capacity	Thermometer & Setpoint Scales	Control Action		
					D (DA) / N (DA)	D (RA) / N (RA)	D (DA) / N (DA) (with Night Vent)
192 DN	Single	Dual (Day and Night)	High (Integral Relay)	°F	192-204	192-205	192-206
192 DNV 3-pipe				°C	192-224	192-225	192-226

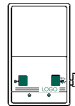
Chassis Options: Chassis with 1/2" (13 mm) diameter setpoint adjustment knob for convalescent facilities. Available in Desert Beige only. Add a "K" to the end of the Part No., for example **192-204K**.

Thermostat Covers (Sold Separately)	Plastic Part No.		Metal Part No.
	Desert Beige	White	
 <ul style="list-style-type: none"> • Adjustment setpoint concealed • Indicator setpoint concealed • Chassis thermometer concealed 	192-262	192-262W	192-362
 <ul style="list-style-type: none"> • Adjustment setpoint concealed • Indicator setpoint concealed • Chassis thermometer exposed 	192-264	192-264W	192-364
 <ul style="list-style-type: none"> • Adjustment setpoint key • Indicator setpoint exposed • Chassis thermometer concealed • Use with 1/2" setpoint knob option 	192-269	192-269W	192-369
 <ul style="list-style-type: none"> • Adjustment setpoint key • Indicator setpoint exposed • Chassis thermometer exposed • Use with 1/2" setpoint knob option 	192-270	192-270W	192-370
 <ul style="list-style-type: none"> • Adjustment setpoint key (night) exposed (day) • Indicator setpoint exposed • Chassis thermometer exposed 	192-271	192-271W	192-371

Note:

- DNV 3-pipe model provides full air supply on R2 vent port during night control cycle.
- "Exposed features" are indicated in **green** on corresponding illustration.
- For **194** refer to Powerstar Retroline section.
- Universal Cover sold on page **A-83**.

Powerstar Free Energy Band Heating/Cooling Pneumatic Room Thermostats



193 HC Thermostat chassis.



Typical wall plate and screws.



193 HC Thermostat with plastic cover. Chassis wall plate with easy maintenance plug-in adapters shown (optional).



Description

Providing proportional, dual output, dual setpoint, 2-pipe (dual 1-pipe low air capacity) or 3-pipe (dual 2-pipe high air capacity) pneumatic room temperature control, the 193 HC Powerstar Free Energy Band Pneumatic Room Thermostat creates a deadband so that no heating or cooling occurs during the Free Energy Band.

Features

- Dual setpoint dials available in Fahrenheit or Celsius scales
- Integral, field adjustable limit stops
- Sensitive bimetal responds to temperature changes
- Adjustable Free Energy Band
- Test port for fast check of output pressure without removing the cover
- Wall mounting plates for connection to a variety of rough-in terminal boxes included
- Field replaceable thermometer, setpoint dials, restrictors and filters
- Competitive adapter mounting kits available

Options

- Fixed limit stops to meet government specifications
- Quick-connect air connections for ease of installation and service
- Large, 1/2" setpoint knob for convalescent homes

Input/Output Characteristics

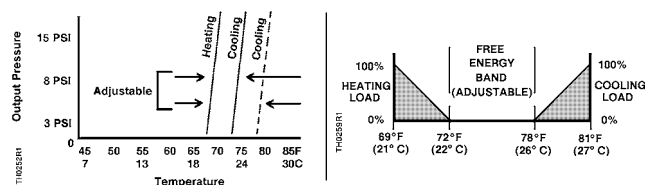

Applications

Designed for buildings with early morning heat requirements and mid-morning to afternoon cooling requirements, the Powerstar Free Energy Band Pneumatic Room Thermostat two temperature thermostat controls valves, damper actuators and mechanical heating and cooling equipment. Providing energy management and occupant comfort, the thermostat automatically reduces heating load and increases cooling load.

Recommendation

2-pipe (dual 1-pipe): Use when a limited air capacity is required to operate a single valve and/or actuator.

3-pipe (dual 2-pipe): Use for multiple valves and actuators with or without high/low limiting controls which require higher air capacities.

Application Drawings

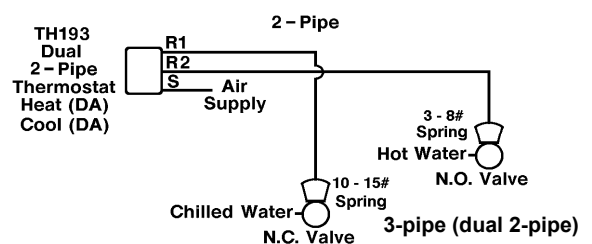
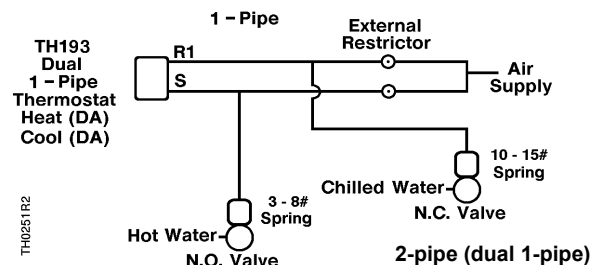

193 HC Thermostat Specifications

For complete conversion kits, refer to the Retroline® Retrostats starting on page A-15.

Scale; Range

Major (minor) Divisions..... 45 to 85°F, 10(2)°F (7 to 30°C, 5(1)°C)

Factory Calibration 72°F, 7.5 psi ±0.3
(22°C, 52 kPa @ 1.8)

Sensitivity Adjustment Range 1 to 4 psi/°F (12 to 50 kPa/°C)

Factory Setting 2.5 psi/°F (31 kPa/°C)

Limit Stop

Field Adjustment Range 45/85°F (7/30°C)

Fixed Limit Stop Range 55/75°F (13/24°C)

Temperature

Storage -10 to +140°F (-23 to +60°C)

Ambient Operating 40 to 140°F (4 to 60°C)

Accuracy at Factory

Calibration ±2°F (±1.1°C)

Response 0.1°F (0.06°C)

Supply Air Pressure

Two Pressure (recommended) 25 psi (172 kPa)

Maximum 30 psi (207 kPa)

Nominal Air Consumption for Air Compressor Sizing

1-pipe 50 scim (14 ml/s)

2-pipe 40 scim (11 ml/s)

Nominal Air Capacity for Air Main Sizing

1-pipe 50 scim (14 ml/s)

2-pipe 40 scim (11 ml/s)

Nominal Chassis Air Capacity

1-pipe Supply 25 scim (6.8 ml/s) per side

2-pipe Supply 230 scim (63 ml/s) per side

1-pipe Exhaust 30 scim (8 ml/s) per side

2-pipe Exhaust 150 scim (41 ml/s) per side

Air Connections

..... 5/32" (4 mm) OD tubing

Dimensions (with cover)

..... 2.16" W x 3.34" H x 1.59" D

Shipping Weights

Thermostat Chassis and Wall Plate 0.53 lb. (0.24 kg)

Plastic Cover 0.07 lb. (0.04 kg)







Metal Cover (dual) 0.27 lb. (0.12 kg)

193 HC Thermostat Product Ordering

Model #	Thermostat Chassis Type				Thermostat Chassis & Wall Plate	
	Output	Setpoint	Air Output Capacity	Thermometer & Setpoint Scales	Control Action	
					Heat Direct	Heat Reverse
193 HC 1-pipe	Single	Dual (Heat and Cool)	Low (No Relay)	°F	193-211 Cool (DA)	193-213 Cool (DA)
				°F	193-212 Cool (RA)	193-214 Cool (RA)
				°C	193-231 Cool (DA)	193-233 Cool (DA)
				°C	193-232 Cool (RA)	193-234 Cool (RA)
193 HC 2-pipe		Dual (Heat and Cool)	High (Integral Relay)	°F	193-215 Cool (DA)	193-217 Cool (DA)
				°F	193-216 Cool (RA)	193-218 Cool (RA)
				°C	193-235 Cool (DA)	193-237 Cool (DA)
				°C	193-236 Cool (RA)	193-238 Cool (RA)

Chassis Options: Chassis with 1/2" (13 mm) diameter setpoint adjustment knob for convalescent facilities.

Available in Desert Beige only. Add a "K" to the end of the Part No., for example 193-211K.

Thermostat Covers (Sold Separately)	Plastic Part No.		Metal Part No.
	Desert Beige	White	
 <ul style="list-style-type: none"> • Adjustment setpoint concealed • Indicator setpoint concealed • Chassis thermometer concealed • No logo 	192-257	192-257W	192-357
 <ul style="list-style-type: none"> • Adjustment setpoint concealed • Indicator setpoint concealed • Chassis thermometer concealed • With logo 	192-256	192-256W	192-356
 <ul style="list-style-type: none"> • Adjustment setpoint concealed • Indicator setpoint concealed • Chassis thermometer exposed 	192-254	192-254W	192-354
 <ul style="list-style-type: none"> • Adjustment setpoint key • Indicator setpoint exposed • Chassis thermometer concealed 	192-267	192-267W	192-367
 <ul style="list-style-type: none"> • Adjustment setpoint key • Indicator setpoint exposed • Chassis thermometer exposed • Use with 1/2" setpoint knob option 	192-268	192-268W	192-368
 <ul style="list-style-type: none"> • Adjustment setpoint exposed • Indicator setpoint exposed • Chassis thermometer concealed • Use with 1/2" setpoint knob option 	192-258	192-258W	192-358
 <ul style="list-style-type: none"> • Adjustment setpoint exposed • Indicator setpoint exposed • Chassis thermometer concealed 	192-260	192-260W	192-360

Note: • "Exposed features" are indicated in green on corresponding illustration.
• Universal Cover sold on page A-33.



Part No. in black box Ships same day when requested through Rapid Response™ shipping. See inside back cover for details.

SIEMENS

A-12

Thermostats

Powerstar (Hesitation) Free Energy Band Heating/Cooling Pneumatic Room Thermostats



193 HC Thermostat chassis.



Typical wall plate and screws.



193 HC Thermostat with plastic cover. Chassis wall plate with easy maintenance plug-in adapters shown (optional).

Description

Providing proportional, single output, dual setpoint, 2-pipe pneumatic room temperature control, the 193 HC Powerstar (Hesitation) Free Energy Band Heating/Cooling Pneumatic Room Thermostat is designed to sequence a heating device or a cooling device.

The hesitation feature keeps the output pressure constant through a 6°F (10.8°C) range (typical), causing a deadband.

Features

- Dual setpoint dials available in Fahrenheit or Celsius scales
- Sensitive bimetal responds to temperature changes
- Integral, field adjustable limit stops
- Adjustable Free Energy Band
- Wall mounting plate for connection to a variety of rough-in terminal boxes included
- Test port for fast check of output pressure without removing the cover
- Field replaceable thermometer, setpoint dials, restrictors, and filters

Options

- Fixed limit stops to meet government specifications
- Quick-connect air connections for ease of installation and service
- Large, 1/2" setpoint knob for convalescent homes

Applications

The 193 HC Powerstar (Hesitation) Free Energy Band Heating/Cooling Pneumatic Room Thermostat is an excellent choice for saving energy by sequencing heating and cooling valves. In most heat/cool pneumatic applications, a 3 to 8 psi (21 to 55 kPa) heating valve and a 10 to 14 psi (69 to 103 kPa) cooling valve is used. By design, this provides a 2 psi (14 kPa) deadband where no heating or cooling is occurring. The hesitation feature allows you to change the deadband range to a 3, 4 or 5 psi (21, 28, or 34 kPa) range to save energy. Refer to the Input/Output chart below for more information.

Application Drawing

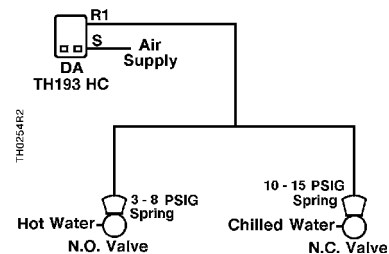

Input/Output Characteristics

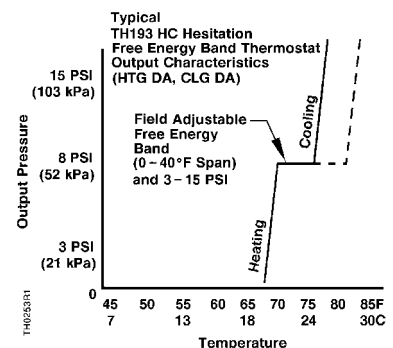
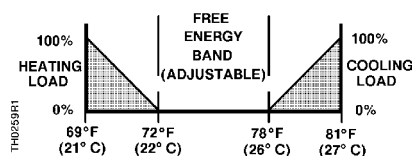

193 HC Thermostat Specifications

Scale; Range
 Major (minor) Divisions..... 45 to 85°F, 10(2)°F/
 (7 to 30°C, 5(1)°C)

Factory Calibration
 "FEB" Output Pressure..... 7.5 psi (52 kPa)
 Temperature 72°F (22°C)
 Sensitivity 2.5 psi/°F (31 kPa/°C)

Sensitivity Adjustment Range 1 to 4 psi/°F
 (12 to 50 kPa/°C)

Limit Stop, Field Adjustment Range 55/75°F (13/24°C)

Temperature
 Storage..... -10 to +140°F (-23 to +60°C)
 Ambient Operating 40 to 140°F (4 to 60°C)

Accuracy at Factory
 Calibration ±2°F (±1.1°C)
 Response 0.1°F (0.06°C)

Supply Air Pressure
 Recommended..... 25 psi (172 kPa)
 Maximum..... 30 psi (207 kPa)

Free Energy Band
 Output Pressure Adjustment 1 to 15 psi (7 to 103 kPa)
 Range..... 0 to 40°F (0 to 20°C)

Nominal Air Capacity for Compressor Sizing 40 scim (11 ml/s)

Nominal Air Capacity for Air Main Sizing 40 scim (11 ml/s)

Nominal Chassis Air Capacity
 Supply 150 scim (41 ml/s)
 Exhaust 150 scim (41 ml/s)
 Supply/2-pipe Exhaust 150 scim (41 ml/s) per side

Air Connections 5/32" (4 mm) OD tubing







Dimensions (with cover) 2.16" W x 3.34" H x 1.59" D
 (55 mm W x 85 mm H x 40 mm D)

Shipping Weights
 Thermostat Chassis and Wall Plate 0.53 lb. (0.24 kg)
 Plastic Cover 0.07 lb. (0.04 kg)
 Metal Cover (dual)..... 0.27 lb. (0.12 kg)

193 HC Thermostat Product Ordering

Model #	Thermostat Chassis Type				Thermostat Chassis & Wall Plate	
	Output	Setpoint	Air Output Capacity	Thermometer & Setpoint Scales	Control Action	
					Heat (DA) / Cool (DA)	Heat (RA) / Cool (RA)
193 HC Hesitation	Single	Dual (Heat and Cool)	High (Integral Relay)	°F	193-219	193-220
°C				193-239	193-240	

Chassis Options: Chassis with 1/2" (13 mm) diameter setpoint adjustment knob for convalescent facilities. Available in Desert Beige only. Add a "K" to the end of the Part No., for example **193-219K**.

Thermostat Covers (Sold Separately)	Plastic Part No.		Metal Part No.
	Desert Beige	White	
 <ul style="list-style-type: none"> • Adjustment setpoint concealed • Indicator setpoint concealed • Chassis thermometer concealed • No logo 	192-257	192-257W	192-357
 <ul style="list-style-type: none"> • Adjustment setpoint concealed • Indicator setpoint concealed • Chassis thermometer concealed • With logo 	192-256	192-256W	192-356
 <ul style="list-style-type: none"> • Adjustment setpoint concealed • Indicator setpoint concealed • Chassis thermometer exposed 	192-254	192-254W	192-354
 <ul style="list-style-type: none"> • Adjustment setpoint key • Indicator setpoint exposed • Chassis thermometer concealed 	192-267	192-267W	192-367
 <ul style="list-style-type: none"> • Adjustment setpoint key • Indicator setpoint exposed • Chassis thermometer exposed • Use with 1/2" setpoint knob option 	192-268	192-268W	192-368
 <ul style="list-style-type: none"> • Adjustment setpoint exposed • Indicator setpoint exposed • Chassis thermometer concealed • Use with 1/2" setpoint knob option 	192-258	192-258W	192-358
 <ul style="list-style-type: none"> • Adjustment setpoint exposed • Indicator setpoint exposed • Chassis thermometer concealed 	192-260	192-260W	192-360

Note: • "Exposed features" are indicated in green on corresponding illustration.
 • Universal Cover sold on page A-83.



Part No. in black box Ships same day when requested through Rapid Response™ shipping. See inside back cover for details.

SIEMENS

RETROLINE® Powerstar Retrostat Pneumatic Room Thermostats

RETROLINE®
easily replaces:

- Barber-Colman (Siebe)
- Johnson Controls
- Honeywell
- Robertshaw (Siebe)

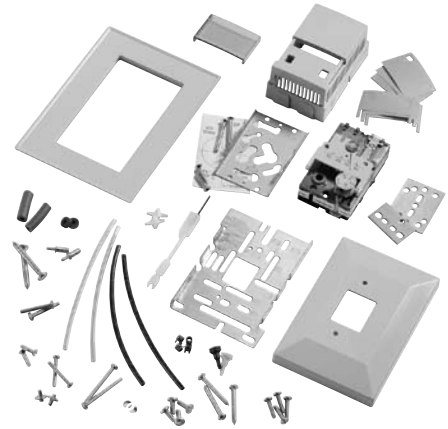

192/194 Dual Setpoint Pneumatic Room Thermostat Kit.

Description

The Powerstar Retroline Retrostat Pneumatic Room Thermostat converts most existing pneumatic room thermostats to a Powerstar 192/194 direct or reverse acting, 2-pipe, single or dual setpoint unit.

Day/Night or Heat/Cool Retrostat is factory calibrated to match the appropriate changeover pressure of the competitive thermostat.

Features

- Complete kit including Retrostat cover kit with exposed or concealed setpoint adjustment
- Setpoint dials available in Fahrenheit or Celsius scales
- Factory calibrated for accuracy
- All installation hardware and calibration wrench provided.
- Fits into large format wall openings, using included "goof plate."
- Integral, field adjustable limit stops
- Test port for fast check of output pressure without removing the cover
- Field replaceable thermometer, setpoint dial(s), restrictor(s), and filter(s)

Options

- Quick-connect air connections for ease of installation and service
- Large, 1/2" setpoint knob for convalescent homes

Applications

Retroline Retrostat kits are available for most 2-pipe applications in direct and reverse acting models, including:

- Single Temperature
- Day/Night
- Heat/Cool

Refer to the Powerstar products to select the appropriate application.

192/194 Pneumatic Room Thermostats Specifications

Single Setpoint			
Description	Thermometer & Setpoint Scales	Control Action	
		Direct	Reverse
Single Temperature	°F	192-840	192-841
	°C	192-850	192-851

Kits include covers.

If a different cover is required, refer to the Accessories and Service Kit section.



Dual Setpoint				
Action/Changeover Pressure	Manufacturer	Thermometer & Setpoint Scales	Kit Part No. (Desert Beige)	Kit Part No. (White)
Day/Night				
Day (DA) 13 psi (90 kPa) / Night (DA) 18 psi (124 kPa)	Honeywell	°F	194-3042	194-3042W
Day (DA) 13 psi (90 kPa) / Night (DA) 18 psi (124 kPa)	Honeywell	°C	194-3142	194-3142W
Day (DA) 15 psi (103 kPa) / Night (DA) 20 psi (138 kPa)	Johnson/B-C	°F	194-3043	194-3043W
Day (DA) 15 psi (103 kPa) / Night (DA) 20 psi (138 kPa)	Johnson/B-C	°C	194-3143	194-3143W
Day (DA) 18 psi (124 kPa) / Night (DA) 25 psi (172 kPa)	Siemens	°F	192-3044	192-3044W
Day (DA) 18 psi (124 kPa) / Night (DA) 25 psi (172 kPa)	Siemens	°C	192-3144	192-3144W
Day (RA) 13 psi (90 kPa) / Night (RA) 18 psi (124 kPa)	Honeywell	°F	194-3052	194-3052W
Day (RA) 15 psi (103 kPa) / Night (RA) 20 psi (138 kPa)	Johnson/B-C	°F	194-3053	194-3053W
Day (RA) 18 psi (124 kPa) / Night (RA) 25 psi (172 kPa)	Siemens	°F	192-3054	192-3054W
Day (RA) 18 psi (124 kPa) / Night (RA) 25 psi (172 kPa)	Siemens	°C	192-3154	192-3154W
Heat/Cool				
Heat (DA) 18 psi (124 kPa) / Cool (RA) 13 psi (90 kPa)	Honeywell	°F	194-3082	194-3082W
Heat (DA) 20 psi (138 kPa) / Cool (RA) 15 psi (103 kPa)	Johnson/B-C	°F	194-3083	194-3083W
Heat (DA) 25 psi (172 kPa) / Cool (RA) 18 psi (124 kPa)	Siemens	°F	192-3084	192-3084W
Heat (DA) 25 psi (172 kPa) / Cool (RA) 18 psi (124 kPa)	Siemens	°C	192-3184	192-3184W

- Note:**
- For detailed specifications on Day/Night, refer to 192 DN or DNV.
 - For detailed specifications on Heat/Cool, refer to 193 HC.
 - The changeover pressures for RobertShaw thermostats are 16 psi Day/25 psi Night.
 - All kits include covers.

Chassis Options: Chassis with 1/2" (13 mm) diameter setpoint adjustment knob for convalescent facilities. Available in Desert Beige only. Add a "K" to the end of the Part No., for example **192-207K**.

A-16

Thermostats

Accessories & Service Kits A-75

Retroline Powerstar Retrostat Pneumatic Room Thermostat Product Ordering

Manufacturer Part No.	Manufacturer	Control Action/Temperature Scale	Retroline Part No.	
			Kit	Replace. Chassis
T-4002-201 ¹	Johnson Controls	Single Temperature, Direct Acting	192-840	192-202
T-4002-202 ¹	Johnson Controls	Single Temperature, Reverse Acting	192-841	192-203
T-4002-203	Johnson Controls	Single Temperature, Direct Acting	192-840	192-202
T-4002-204	Johnson Controls	Single Temperature, Reverse Acting	192-841	192-203
T-4506-201 ¹	Johnson Controls	Day (DA) 15 psi (103 kPa) changeover / Night (DA) 20 psi (138 kPa)	194-3043	194-2043
T-4506-202	Johnson Controls	Day (DA) 15 psi (103 kPa) changeover / Night (DA) 20 psi (138 kPa)	194-3043	194-2043
T-4506-203 ^{1, 2}	Johnson Controls	Day (DA) 15 psi (103 kPa) changeover / Night (DA) 20 psi (138 kPa)	194-3043	194-2043
T-4506-204 ²	Johnson Controls	Day (DA) 15 psi (103 kPa) changeover / Night (DA) 20 psi (138 kPa)	194-3043	194-2043
T-4506-201 ¹	Johnson Controls	Day (DA) 15 psi (103 kPa) changeover / Night (DA) 20 psi (138 kPa)	194-3043	194-2043
T-4506-202	Johnson Controls	Day (DA) 15 psi (103 kPa) changeover / Night (DA) 20 psi (138 kPa)	194-3043	194-2043
T-4506-203 ^{1, 2}	Johnson Controls	Day (DA) 15 psi (103 kPa) changeover / Night (DA) 20 psi (138 kPa)	194-3043	194-2043
T-4506-204 ²	Johnson Controls	Day (DA) 15 psi (103 kPa) changeover / Night (DA) 20 psi (138 kPa)	194-3043	194-2043
T-4506-209 ¹	Johnson Controls	Day (RA) 15 psi (103 kPa) changeover / Night (RA) 20 psi (138 kPa)	194-3053	194-2053
T-4506-217 ^{1, 2}	Johnson Controls	Day (RA) 15 psi (103 kPa) changeover / Night (RA) 20 psi (138 kPa)	194-3053	194-2053
T-4756-205 ¹	Johnson Controls	Heat (DA) 20 psi (138 kPa) changeover / Cool (RA) 15 psi (103 kPa)	194-3083	194-2083
T-4756-206	Johnson Controls	Heat (DA) 20 psi (138 kPa) changeover / Cool (RA) 15 psi (103 kPa)	194-3083	194-2083
TP970A1002	Honeywell	Single Temperature, Direct Acting	192-840	192-202
TP970A1012	Honeywell	Single Temperature, Direct Acting	192-840	192-202
TP970A1035	Honeywell	Single Temperature, Direct Acting	192-840	192-202
TP970A1038	Honeywell	Single Temperature, Direct Acting	192-840	192-202
TP970A1053	Honeywell	Single Temperature, Direct Acting	192-840	192-202
TP970A1061	Honeywell	Single Temperature, Direct Acting	192-840	192-202
TP970A2004	Honeywell	Single Temperature, Direct Acting	192-840	192-202
TP970A1002	Honeywell	Single Temperature, Reverse Acting	192-841	192-203
TP970B1028	Honeywell	Single Temperature, Reverse Acting	192-841	192-203
TP970B1036	Honeywell	Single Temperature, Reverse Acting	192-841	192-203
TP970B1044	Honeywell	Single Temperature, Reverse Acting	192-841	192-203
TP971A1003	Honeywell	Day (DA) 13 psi (90 kPa) changeover / Night (DA) 18 psi (124 kPa)	194-3042	194-2042
TP971A1029	Honeywell	Day (DA) 13 psi (90 kPa) changeover / Night (DA) 18 psi (124 kPa)	194-3042	194-2042
TP971A1037	Honeywell	Day (DA) 13 psi (90 kPa) changeover / Night (DA) 18 psi (124 kPa)	194-3042	194-2042
TP971A1045	Honeywell	Day (DA) 13 psi (90 kPa) changeover / Night (DA) 18 psi (124 kPa)	194-3042	194-2042
TP971A1086	Honeywell	Day (DA) 13 psi (90 kPa) changeover / Night (DA) 18 psi (124 kPa)	194-3042	194-2042
TP971B1001	Honeywell	Day (RA) 13 psi (90 kPa) changeover / Night (RA) 18 psi (124 kPa)	194-3052	194-2052
TP971B1004	Honeywell	Day (RA) 13 psi (90 kPa) changeover / Night (RA) 18 psi (124 kPa)	194-3052	194-2052
TP972A1002	Honeywell	Heat (DA) 18 psi (124 kPa) changeover / Cool (RA) 13 psi (90 kPa)	194-3082	194-2082
TP972A1028	Honeywell	Heat (DA) 18 psi (124 kPa) changeover / Cool (RA) 13 psi (90 kPa)	194-3082	194-2082
TP972A1036	Honeywell	Heat (DA) 18 psi (124 kPa) changeover / Cool (RA) 13 psi (90 kPa)	194-3082	194-2082
TP972A1101	Honeywell	Heat (DA) 18 psi (124 kPa) changeover / Cool (RA) 13 psi (90 kPa)	194-3082	194-2082

A-17

Thermostats

Ordering Notes

1. Suggested Retrofit Kit converts horizontal thermostat to vertical position.
2. Suggested Retrofit Kit has an additional manual changeover switch, not provided on the original.



Retroline Powerstar Retrostat Pneumatic Room Thermostat Product Ordering

Manufacturer Part No.	Manufacturer	Control Action/Temperature Scale	Retroline Part No.	
			Kit	Replace. Chassis
TK-18	Barber-Colman	Single Temperature, Direct Acting	192-840	192-202
TK-19	Barber-Colman	Single Temperature, Reverse Acting	192-841	192-203
TK-19-1	Barber-Colman	Single Temperature, Reverse Acting	192-841	192-203
TK-19-19	Barber-Colman	Single Temperature, Reverse Acting	192-841	192-203
TK-1001	Barber-Colman	Single Temperature, Direct Acting	192-840	192-202
TK-1101	Barber-Colman	Single Temperature, Reverse Acting	192-841	192-203
TK-1001-116	Barber-Colman	Single Temperature, Direct Acting	192-850	192-222
TK-1002	Barber-Colman	Single Temperature, Direct Acting	192-840	192-202
TK-1002	Barber-Colman	Single Temperature, Reverse Acting	192-841	192-203
TK-5001-116	Barber-Colman	Single Temperature, Direct Acting	192-850	192-222
TKR-18	Barber-Colman	Single Temperature, Direct Acting	192-840	192-202
TKR-18-91	Barber-Colman	Single Temperature, Direct Acting	192-840	192-202
TKR-19	Barber-Colman	Single Temperature, Reverse Acting	192-841	192-203
TKR-1001	Barber-Colman	Single Temperature, Direct Acting	192-840	192-202
TKR-1101	Barber-Colman	Single Temperature, Reverse Acting	192-841	192-203
2212-118	Robertshaw	Single Temperature, Direct Acting	192-840	192-202
2212-119	Robertshaw	Single Temperature, Reverse Acting	192-841	192-203
2212-128	Robertshaw	Single Temperature, Direct Acting	192-840	192-202
2212-129	Robertshaw	Single Temperature, Reverse Acting	192-841	192-203
2212-418	Robertshaw	Single Temperature, Direct Acting	192-840	192-202
2212-419	Robertshaw	Single Temperature, Reverse Acting	192-841	192-203
2212-518	Robertshaw	Single Temperature, Direct Acting	192-840	192-202
2212-519	Robertshaw	Single Temperature, Reverse Acting	192-841	192-203
T15-101	Robertshaw	Single Temperature, Direct Acting	192-840	192-202
T18-101	Robertshaw	Single Temperature, Direct Acting	192-840	192-202
T18-201	Robertshaw	Single Temperature, Direct Acting	192-840	192-202
T18-301	Robertshaw	Single Temperature, Direct Acting	192-840	192-202
T18-3011	Robertshaw	Single Temperature, Direct Acting	192-840	192-202
192-202	Powers	Single Temperature, Direct Acting	192-840	192-202
192-203	Powers	Single Temperature, Reverse Acting	192-841	192-203
192-204	Powers	Day (DA) 18 psi (124 kPa)/Night (DA) 25 psi (172 kPa) changeover	192-3044	192-204
192-205	Powers	Day (RA) 18 psi (124 kPa)/Night (RA) 25 psi (172 kPa) changeover	192-3054	192-205
192-208	Powers	Heat (DA) 25 psi (172 kPa)/Cool (RA) 18 psi (124 kPa) changeover	192-3084	192-208
192-222	Powers	Single Temperature, Direct Acting	192-850	192-222
192-223	Powers	Single Temperature, Reverse Acting	192-851	192-223
192-224	Powers	Day (DA) 18 psi (124 kPa) changeover/Night (DA) 25 psi (172 kPa)	192-3144	192-224
192-225	Powers	Day (RA) 18 psi (124 kPa) changeover/Night (RA) 25 psi (172 kPa)	192-3154	192-225
192-228	Powers	Heat (DA) 25 psi (172 kPa) changeover/Cool (RA) 18 psi (124 kPa)	192-3184	192-228

A-18

Thermostats



Part No. in black box Ships same day when requested through Rapid Response™ shipping. See inside back cover for details.

SIEMENS

Pneumatic Room Thermostats



832 D Pneumatic Room Thermostat and screws.

Description

The single setpoint, direct acting thermostat provides gradual acting pneumatic room temperature control for heating and cooling applications. The 832 D Thermostat is ruggedly constructed for dependable, long-term service.

Features

- All metal construction
- Rapid response to temperature change
- Unique design of supply and exhaust air valves prevents waste
- Quiet operation
- Easy-to-calibrate and service
- Tamper-proof cover screws
- Exposed remote changeover control
- Calibrated thermometer

Applications

Designed for controlling rooms heated or cooled by radiation, ventilation, or an air conditioning system, the 832 D Pneumatic Room Thermostat is versatile and responsive for individual room control.

Other applications include room control of radiant panels, finned radiation, and unit ventilators.

Application Drawing

Dotted lines are alternative control schemes.

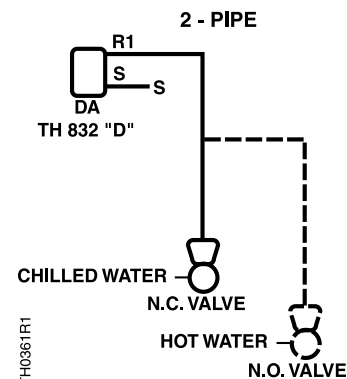

832 D Pneumatic Room Thermostat Specifications

Control Action	Direct	Maximum Operating Pressure	30 psi (207 kPa)
Operating Range	60 to 85°F (15 to 30°C)	Dimensions	2.88" W x 5.63" H x 2.19" D (73 mm W x 143 mm H x 56 mm D)
Sensitivity Fixed	2.5 psi/°F (31 kPa/°C)	Air Consumption for Compressor Sizing	10 scim (2.7 ml/s)
Temperature Response	0.5°F (0.3°C)	Cover Style	Key or concealed setpoint adjustment
Maximum Ambient Temperature	110°F (43°C)	Cover Finish	Silver; Special order other finishes.
Dial Graduations	2°F (1.1°C)	Shipping Weight	3.0 lb. (1.36 kg)
Normal Air Supply Pressure	18 psi (124 kPa)		

832 D Pneumatic Room Thermostat Product Ordering

Description	Thermostat Part No. ²	Cover Assembly
Concealed Adjustment with Thermometer	832-0120	856-036
Concealed Adjustment without Thermometer	832-0490	856-046 ¹
Exposed Key Adjustment with Thermometer	832-0500	856-044
Exposed Knob Adjustment with Thermometer	832-1260	856-044

Ordering Notes

1. Blind cover, **856-046**, does not include mounting screws, **856-014**, that are required for installation.
2. Does not include adjustment key, **856-055**, that is required for installation.

Thermostat comes complete with cover.

A-20



Order the Calibration Kit in the Accessories and Service Kits section.

Accessories & Service Kits

A-75

TECH TIP

To calibrate any pneumatic thermostat, perform the following:

1. Remove the cover.
2. Measure the ambient temperature.
3. Set the setpoint dial to the ambient temperature.
4. Measure the controller output pressure (branch pressure).
5. Turn the calibration screw(s) until the branch pressure equals the midpoint of the control span [usually 8 psi (55 kPa)].
6. Replace the cover.

Limitem Rigid Bulb Thermostats



356 Limitem Rigid Bulb Thermostat.

Description

The 356 Limitem Rigid Bulb Thermostat is a pneumatically operated, duct-mounted thermostat, which is available in either direct or reverse acting in a variety of ranges.

Features

- Durable copper motor tube and steel rod temperature sensing element
- Two-valve design reduces air waste
- Duct mounting hardware included
- All metal construction
- 18" (46 cm) sensing tube

Applications

The 356 Limitem Rigid Bulb Thermostat provides primary control for unit ventilators, fan coils and other air handling units. Can also be used as low limit control for air flow to a controlled space.

A-21

Thermostats

Application Drawings

Dotted lines are alternative control schemes.

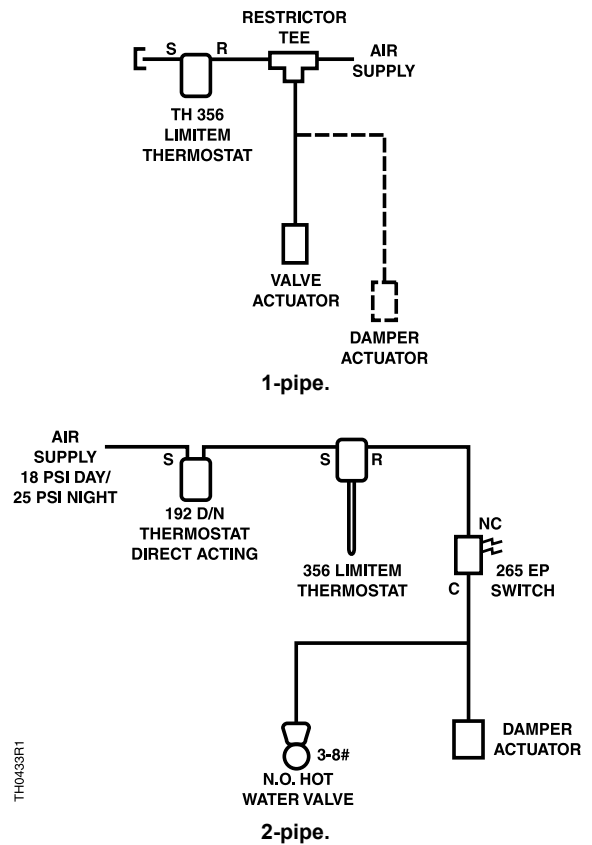

356 Limitem Remote Bulb Thermostat Specifications

Control Action	Direct or Reverse	Nominal Air Supply Pressure	18 to 25 psi (124 to 172 kPa)
Maximum Supply Air Pressure	30 psi (207 kPa)	Maximum External Pressure (on bulb)	250 psi (1722 kPa)
Sensitivity Range (adjustable)	0.25 to 2 psi/°F (3 to 25 kPa/°C)	Mounting	Flange or 3/8" NPT
Factory Sensitivity Setting	1.25 psi/°F (15 kPa/°C)	Air Connections	1/8" NPT
Temperature Response	0.50°F (0.9°C)	Dimensions	
Dial Graduations	5°F (2.7°C)/2°C (3.6°F)	Bulb Length	18" (457 mm)
Maximum Ambient Temperature		Flange OD	2.56" (65 mm)
Case	200°F (93°C)	Case	1.5" Diameter x 3" L (33 mm Diameter x 76 mm L)
Bulb (Direct Acting).....	225°F (107°C)	Shipping Weight	2.0 lb. (0.91 kg)
Bulb (Reverse Acting).....	250°F (121°C)		

356 Limitem Remote Bulb Thermostat Product Ordering

Control Action	Temperature Operating Range	Part No.
Direct Acting	0 to 100 °F (-18 to +38°C)	356-0012
Direct Acting	30 to 180°F (-1.11 to +82.2°C)	356-0750
Reverse Acting	0 to 100°F (-18 to +38°C)	356-0013
Reverse Acting	30 to 180°F (-1.11 to +82.2°C)	356-1005
Reverse Acting	100 to 250°F (37.8 to 121°C)	356-1006

A-22

Accessories & Service Kits

A-75

Thermostats

TECH TIP

When using the Limitem as a one-pipe device, a 40 scim (11 ml/s) restrictor will limit your output to 80% of supply. A 20 scim (5 ml/s) restrictor will limit your output to 60% of supply.

Example: With a 20 scim (5 ml/s) restrictor and 25 psi (11.3 kPa) supply, your maximum output is 15 psi (6.8 kPa).

Limitem Remote Bulb Thermostats



357 D Limitem Remote Thermostat with an average bulb.

Description

The 357 D Limitem Remote Bulb Thermostat is a pneumatically-operated thermostat that is gradual, direct acting with a remote or averaging bulb.

Features

- Direct acting only
- Remote or averaging bulbs for flexibility in installation
- Liquid-filled sensing element for rapid response to temperature changes
- Two-valve design reduces air waste
- Adjustable sensitivity

Applications

The 357 D Limitem Remote Bulb Thermostat provides primary monitoring and control for air handling units or a low limit control.

Application Drawings

Dotted lines are alternative control schemes.

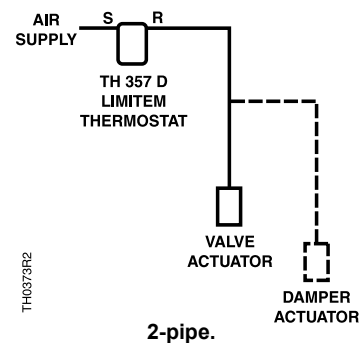

TH0373R2

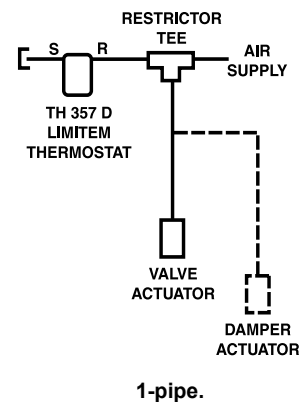

357 D Limitem Remote Bulb Thermostat Specifications

Control Action	Direct	Maximum Ambient Temperature (case)	180°F (82°C)
Maximum Supply Air Pressure	30 psi (207 kPa)	Nominal Air Supply Pressure	18 to 25 psi (124 to 172 kPa)
Sensitivity Range (adjustable)	0.33 to 3.5 psi/°F (4 to 43 kPa/°C)	Mounting	Bracket supplied
Factory Sensitivity Setting	1.25 psi/°F (15 kPa/°C)	Air Connection	1/8" NPT
Bulb	Liquid-filled	Dimensions (Case)	1.75" Diameter x 3.5" H (44.5 mm Diameter x 88.9 mm H)
Temperature Response	0.5°F (0.3°C)	Shipping Weight	2.0 lb. (0.9 kg)
Dial Graduations	5°F (2.7°C), 2°C (3.6°F)		

357 D Limitem Remote Bulb Thermostat Product Ordering

Temperature Operating Range	Sensing Element	Capillary	Bulb	Maximum Ambient Temp.	Part No.
20 to 100°F (-6.7 to +37.8°C)	Remote Bulb	8' (2.4 m)	3/8" x 4' (0.95 mm x 10.2 cm)	201°F (94°C)	357-0003
5 to 145°F (1.7 to 62.8°C)	Averaging Bulb	40' (12.2 m)	3/32" x 15' (0.24 mm x 457 cm)	210°F (99°C)	357-0004
120 to 230°F (48.9 to 110°C)	Remote Bulb	40' (12.2 m)	3/8" x 4" (0.95 mm x 10.2 cm)	261°F (127°C)	357-0005
35 to 145°F (1.7 to 62.8°C)	Averaging Bulb	6" (15 cm)	3/32" x 8' (0.24 mm x 244 cm)	211°F (99.4°C)	357-0001

A-24

Accessories & Service Kits

A-75

Thermostats

Unit Mounted Thermostats

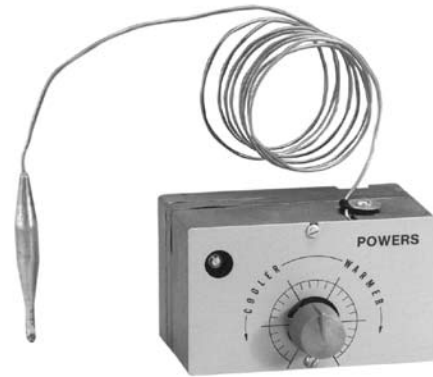

188 Unit Mounted Thermostat.

Description

The 188 Unit Mounted Thermostat is a gradual acting thermostat with a remote bulb operating on the force-balance principle, using pneumatic feedback to obtain linearity and maintain selected room temperature by positioning pneumatic devices to control heating or cooling.

Features

- Liquid-filled thermal system temperature sensing element
- Durable die-cast metal case with rugged setpoint knob
- Adjustable sensitivity
- Universal mounting bracket for easy installation
- Integral adjustable limit stops
- Available as:
 - Direct Acting only (Heating)
 - Reverse Acting only (Cooling)
 - Heat or Cool depending on supply air pressure

Applications

The 188 Unit Mounted Thermostats are designed primarily for use in fan coil induction units and unit ventilators to control the temperature within an occupied space. The thermostat's temperature range is limited to applications at ambient temperatures.

Typical Connections

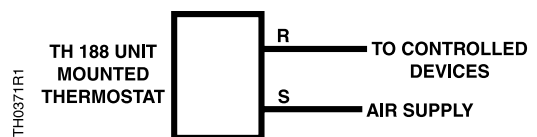

188 Unit Mounted Thermostat Specifications

Control Action Heating/Cooling, Direct and Reverse;
Direct only; Reverse only

Operating Range 60 to 85°F (15.5 to 29.4°C)

Operating Pressure 30 psi (207 kPa) max.

Adjustment Sensitivity 1 to 5.25 psi/°F (12 to 65 kPa/°C)

Factory Sensitivity Setting 2.25 psi/°F (28 kPa/°C)

Temperature Response 0.2°F (0.1°C)

Maximum Ambient Temperature

Case 135°F (57.2°C)

Bulb 231°F (111°C)

Scale Graduations 1°F (0.55°C)

Nominal Air Supply Pressure

Direct or Reverse Acting..... 25 psi (172 kPa)

Heating/Cooling..... 25 psi (172 kPa)/18 psi (124 kPa)

Average Air Usage

20 scim Restrictor..... 25 scim (6.8 ml/s)

40 scim Restrictor..... 45 scim (12.2 ml/s)

Air Connections 1/4" (6 mm) Brass barbed for polyethylene tubing

Bulb Size 3/8" Diameter x 3-1/2" L
(9.5 mm Diameter x 89 mm L)

Capillary Length 48" (121.9 cm) approx.

Finish Corrosion-resistant Zinc Chromate

Dimensions (case)

Heating/Cooling, Reverse Acting..... 3.1" W x 2.4" H x 2.13" D
(100 mm W x 61 mm H x 54 mm D)

Direct Acting 3.1" W x 2.4" H x 1.38" D
(100 mm W x 61 mm H x 35 mm D)

Shipping Weight 3.0 lb. (1.36 kg)

188 Unit Mounted Thermostat Product Ordering

	Control Action	Changeover Pressure	Average Air Usage	Part No.
Single Setpoint	Direct Acting / 25 psi (172 kPa)	—	40 scim (11 ml/s)	188-0031
Single Setpoint	Reverse Acting (Cooling) 18 psi	—	20 scim (5 ml/s)	188-0024
Heat/Cool	Direct Acting / Reverse Acting (Cooling) 18 psi (124 kPa)	—	40 scim (11 ml/s)	188-0030
Heat/Cool	Retroline Direct Acting/Reverse Acting 18 psi (124 kPa) / 13 psi (90 kPa). Retroline replacement for Honeywell LP916BXXXX .	15 psi (103 kPa)	40 scim (11 ml/s)	188-0033
Heat/Cool	Retroline Direct Acting/Reverse Acting 20 psi (138 kPa) / 15 psi (103 kPa). Retroline replacement for Johnson Controls T-3300-2 .	17 psi (117 kPa)	40 scim (11 ml/s)	188-0034

A-26

Thermostats

Accessories & Service Kits

A-75

Pneumatic High and Low Temperature Detection Thermostats



134 Pneumatic Low Temperature Detection Thermostat.

Description

The 134 High and Low Temperature Detection Pneumatic Thermostats automatically “lockout” at setpoint and require manual reset.

Features

- Snap-acting pneumatic switch
- Sight-set calibrated setpoint scale
- No leakage of air prior to reset of switch
- Easily adjustable settings
- Normally closed air valve; bleeds to less than 2 psi (14 kPa) when supplied through a restrictor
- Barb fitting for push-on connection of 1/4" (6 mm) OD polyethylene tubing
- Holds dead-ended line to approximately 22 psi (152 kPa) air pressure

Applications

The 134 Pneumatic High and Low Temperature Detection Thermostats are used on pneumatic heating and cooling systems in areas protected from the weather.

On a typical high limit application, the thermostat shuts down air conditioning or ventilating fans when the duct temperature becomes excessively high. A normally closed switch opens at setpoint.

On a typical low temperature application, the thermostat stops the fan or closes a damper when the temperature drops to the setpoint at any one foot (30.5 cm) or more of the sensing element.

A-27

Thermostats

Application Drawings

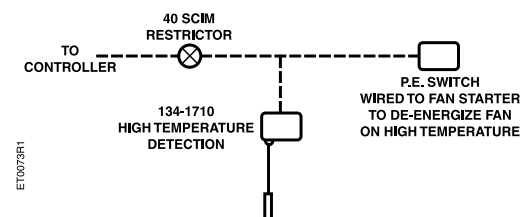
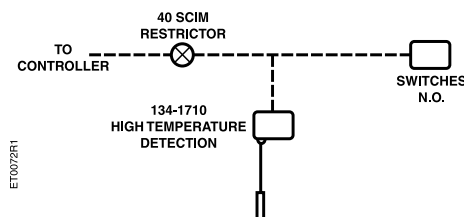
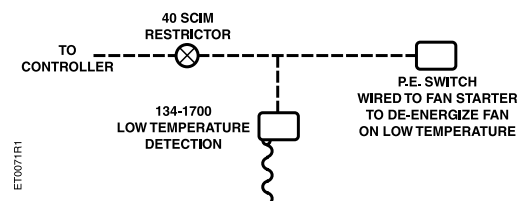
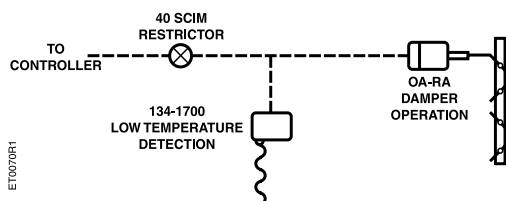

134 Pneumatic Thermostat Specifications

Part No. 134-1700

Ambient Temperature RangeGreater than setpoint to 140°F (60°C)
Pneumatic SwitchNC, 0.020" (0.6 mm) diameter bleed
Control Point Low Temperature ThermostatLowest temperature at any one foot section of the sensing bulb
Case Finish Gray Baked Enamel
Shipping Weight2.45 lb. (1.11 kg)

Part No. 134-1710

Ambient Temperature Range-40 to +140°F (-40 to +60°C)
Pneumatic SwitchNC, 0.02" (0.6 mm) diameter bleed
Control Point Low Temperature ThermostatLowest temperature at any one foot section of the sensing bulb
Case Finish Gray Baked Enamel
Shipping Weight2.38 lb. (1.08 kg)

134 Pneumatic Thermostat Product Ordering

Temp.	Temperature Range	Differential	Max. Bulb Temp.	Bulb & Capillary Length	Switch Reclose	Part No.
Low	15 to 55°F (-9 to +12.8°C) with stop at 35°F (1.67°C)	5°F (2.8°C) Non-Adjustable	400°F (204°C)	20' (6 m)	Temperature must increase by 5°F (2.8°C) before pneumatic switch can be reclosed.	134-1700
High	100 to 170°F (38 to 77°C)	10°F (5.6°C) Non-Adjustable	250°F (121°C)	2.7" (69 mm) Dia. x 10" (25.4 cm) L bulb with 6' (183 mm) capillary	Temperature must drop 10°F (5.6°C) before pneumatic switch can be reclosed.	134-1710

A-28

Thermostats

Accessories & Service Kits

A-75

Dimensions

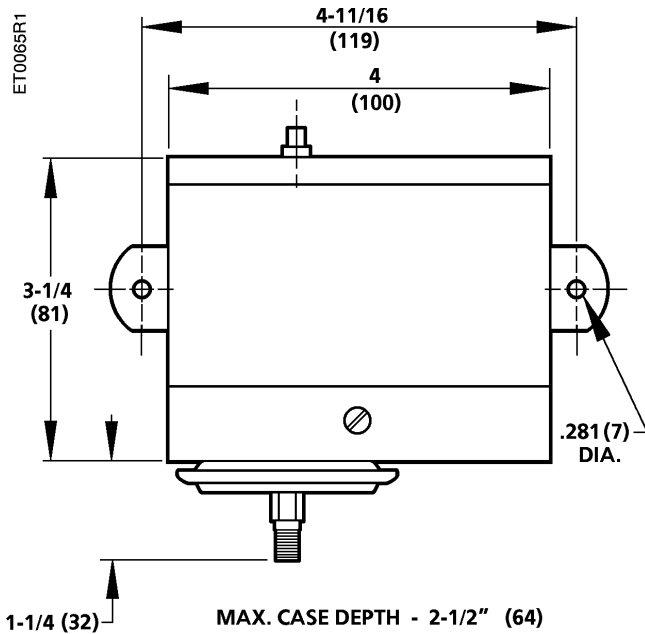

Dimensions shown in inches (mm).

Electric Line Voltage Remote Bulb Thermostats



141 Electric Line Voltage Remote Bulb Thermostat.

Description

The 141 Electric Line Voltage Remote Bulb Thermostat is a two-position electric line voltage thermostat with remote bulb.

Features

- Temperature sensitive, liquid-filled sensing element
- Single-pole, double-throw snap-acting switches
- Enclosed switches suitable for low or line voltage power switching
- Gray baked enamel case

Applications

The 141 Electric Line Voltage Remote Bulb Thermostat is used for temperature control in heating and cooling application, typically to directly operate two-position damper motor actuators, motor actuated valves, relays and similar equipment. Typical applications includes summer-winter change over and the direct control of liquid or air temperatures where two position (ON-OFF) control is acceptable.

Typical Connections

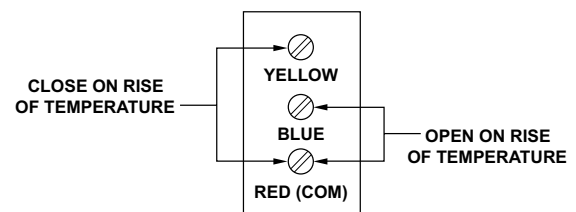

141 Electric Line Voltage Remote Bulb Thermostat Specifications

Inductive Amps

Full Load Amps	
120 Vac.....	7.4
240 Vac.....	3.7
Locked Rotor Amps	
120 Vac.....	44.5
240 Vac.....	22.2

Resistive Amps

120 Vac.....	25
240 Vac.....	20

Dimensions 2.5" W x 5.38" H x 2.31" D
(64 mm x (136 mm x 59 mm))

Shipping Weight 1.8 lb. (0.82 kg)

141 Electric Line Voltage Remote Bulb Thermostat Product Ordering

Temperature Scale Range	Max. Bulb Temp.	Bulb Size	Switch Differential	Part No.
0 to 120°F (-7 to +49°C)	130°F (54°C)	.038" Diameter x 4.03" L (9.9 mm Diameter x 102 mm L) Capillary 6' (183 cm)	Adjustable 6 to 30°F (3 to 16°C)	141-0520
100 to 240°F (38 to 110°C)	250°F (121°C)	.029" Diameter x 2.33" L (7.4 mm Diameter x 59.2 mm L) Capillary 6' (183 cm)	Adjustable 7 to 45°F (14 to 25°C)	141-0521



A-30

Accessories & Service Kits

A-75

Thermostats



Part No. in black box Ships same day when requested through Rapid Response™ shipping. See inside back cover for details.

SIEMENS

Electric Line Voltage Room Thermostats Heating/Cooling



134 Electric Line Voltage Room Thermostat—Heating/Cooling.

Description

The 134 Electric Line Voltage Room Thermostat is a line voltage On/Off room thermostat for heating and cooling applications.

Models are available with SPST or SPDT contact action and for standard, nominal 1/4 hp / 10 amps noninductive, or heavy duty, nominal 1 hp / 22 amps noninductive applications.

Features

- Single setpoint dial
- Exposed bimetal thermometer
- Temperature range from 50 to 90°F (10 to 30°C)
- High and low limit stops
- Standard or heavy duty models
- Dual Fahrenheit/Celsius scale plate

Applications

The 134 Electric Line Voltage Room Thermostat controls heating and cooling applications or year-round air conditioning units in commercial, industrial, or residential installations.

Typical Connections

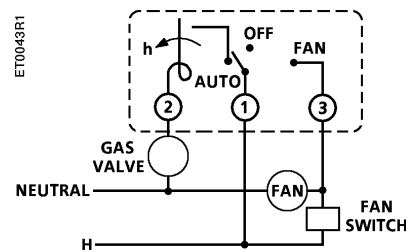

A-31

Thermostats

134 Electric Line Voltage Room Thermostat Specifications

Part No. 134-1083

Motor Rating
 120 Vac 6.0 A
 240 Vac 3.7 A

Switch Action SPST with "Auto-Off-Fan" switch

Dimensions 2.78" W x 5.19" H x 1.88" D
 (71 mm W x 132 mm H x 48 mm D)

Shipping Weight 1.3 lbs. (0.6 kg)

Part No. 134-1086

Motor Rating
 120 Vac 6.0 A
 240 Vac 3.0 A

Switch Action SPST

Dimensions 3" W x 4.75" H x 1.44" D
 (75 mm W x 120 mm H x 36 mm D)

Shipping Weight 1.3 lb. (0.6 kg)

Part No. 134-1084

Motor Rating
 120 Vac 6.0 A
 240 Vac 3.0 A

Resistive Rating
 120 Vac 10.0 amps
 240 Vac 10.0 amps

Switch Action SPDT

Dimensions 3" W x 4.75" H x 1.44" D
 (75 mm W x 120 mm H x 36 mm D)

Shipping Weight 1.0 lb. (0.6 kg)

Part No. 134-1085

Motor Rating
 120 Vac 16.0 Heating/8.0 Cooling
 240 Vac 8.0 Heating/8.0 Cooling

Resistive Rating
 120 Vac 22.0 Heating
 240 Vac 22.0 Heating

Switch Action SPDT

Dimensions 3" W x 4.75" H x 1.44" D
 (75 mm W x 120 mm H x 36 mm D)

Shipping Weight 1.0 lb. (0.6 kg)

A-32

Thermostats

134 Electric Line Voltage Room Thermostat Product Ordering

Switch Action	Temp. Set Point Range	Temp. Set Point Adjustment	Temperature Difference	Part No.
SPST	40 to 90°F (5 to 30°C)	Concealed	1.8°F (1°C)	134-1083
SPST	40 to 90°F (5 to 30°C)	Concealed	1.8°F (1°C)	134-1086
SPDT	40 to 90°F (5 to 30°C)	Exposed Knob or Concealed ¹	1.8°F (1°C) Heating 2.31°F (1.3°C) Cooling	134-1084
SPDT	40 to 90°F (5 to 30°C)	Exposed Knob or Concealed ¹	3°F (1.7°C) Heating 3.5°F (2°C) Cooling	134-1085

Ordering Note

- Each thermostat is shipped with a blank faceplate for use when concealed adjustment is desired.



Accessories & Service Kits A-75



Part No. in black box Ships same day when requested through Rapid Response™ shipping. See inside back cover for details.



Electric Room Thermostats



RAA10C Fan Coil Thermostat with concealed setpoint knob.

RAA20U Room Thermostat with exposed setpoint knob.

Description

Designed for simple heating or cooling or heating/cooling applications, RAA... Electric Room Thermostats are an attractive and economical solution that utilize two-wire, gas membrane technology.

RAA... Electric Room Thermostats are available in single scale Fahrenheit or Celsius models, except the RAA10C, with models for dry wall or electrical wall box mounting. Models designed for wall box mounting include wall box plate adapter and screws.

Features

- Two-point control algorithm for on/off control
- 24 to 120, 277 Vac line
- Two mounting styles: electrical wall box or drywall
- Dual Fahrenheit/Celsius scale (RAA20U)

Options

- Tamperproof cover (concealed setpoint knob) noted with a C
- Available with wall plate

Applications

The RAA... Electric Room Thermostats are typically used in public buildings, storage rooms, entrance hallways and maintenance rooms where two-position (On/Off) control is required.

Descriptions of models are as follows:

RAA10C model is a heating or cooling only thermostat that has a concealed setpoint knob for use in areas where setpoint adjustment is limited to authorized personnel. Typical applications are frost and overheat protection and temporary heat for buildings under construction.

RAA20U model is a heating or cooling only thermostat that has an external setpoint knob for occupant adjustment.

Note:

ARG 70 wall plate is required in order to be UL compliant for switching line voltage.

The RAA... Room Thermostats are designed for either simple heating or cooling or for 2-pipe heating and cooling systems where fan control is not required.

RAA Electric Room Thermostat Specifications

Operating Voltage 24 to 120, 277 Vac
Frequency 50 or 60 Hz
Setpoint Adjustment Range 50 to 85°F (10 to 29°C)
Switching Differential ≤ 1.8°F (1°C)
Switch Rating 6A RES, 3.5 A FLA, 12A LRA
Time Constant 14 min.
Switch Action Output SPDT Two-position (On/Off)
Operation-Conditions
 Operating Temperature 32 to 122°F (0 to 50°C)
 Relative Humidity <95% RH

Transportation/Storage Conditions
 Temperature -4 to +122°F (-20 to +50°C)
 Relative Humidity <95% RH
Housing
 Material Plastic
 Color White
 Bellows Environmentally-friendly gas
Wiring Screw terminals for wires of
 2 x 16 AWG or 1 x 14 AWG, 20 AWG max.
Agency Listings Conforms to CE requirements
 UL listed to 873
 cUL listed to Canadian standard C22.2 No. 24-93
Shipping Weight 0.31 lb. (0.14 kg)

RAA Electric Room Thermostat Product Ordering

Description	Electric Wall Box ¹ Part No.	Dry Wall Part No.
Thermostat for heating or cooling only	RAA10CW	RAA10C
Thermostat for heating or cooling only with exposed setpoint knob	RAA20UW	RAA20U

Ordering Note

- Includes wall plate, **ARG70**, to be UL compliant for switching line voltage.



Accessories & Service Kits

A-75

A-34

Thermostats



Part No. in black box Ships same day when requested through Rapid Response™ shipping. See inside back cover for details.

SIEMENS

RAA Electric Room Thermostat Dimensions

RAA10C... Thermostat

RAA20U... Thermostat

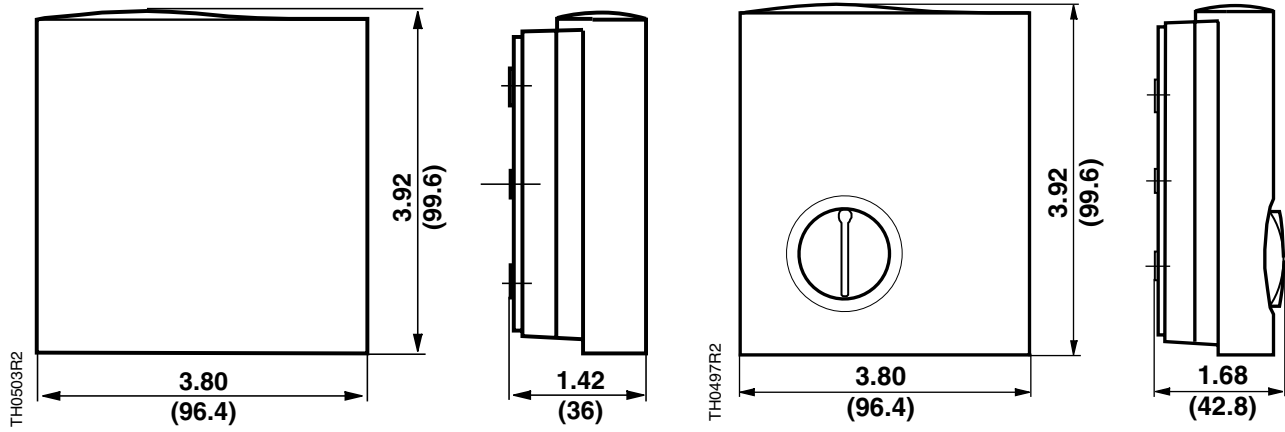

Wall Plate (ARG70) for Mounting (RAA10CW and RAA20UW)

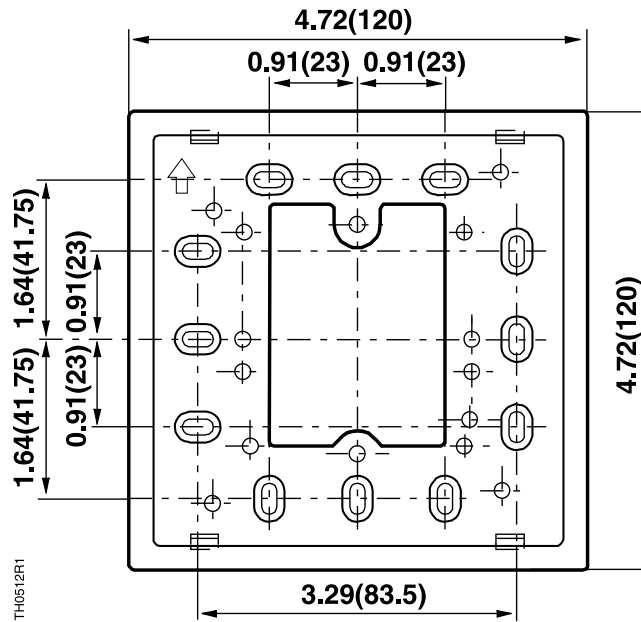

Dimensions shown in inches (mm).

RAA Electric Room Thermostat Engineering Drawings

Wiring Diagrams

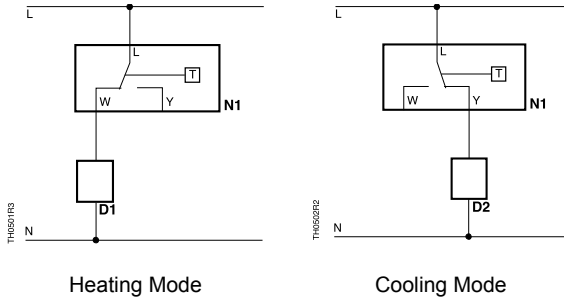

RAA10C.../RAA20U...

- | | |
|----------------------------|---------------------------------|
| Key | |
| D1 Heating device | S On/Off switch |
| D2 Cooling device | T Thermostat |
| L Operating voltage | W Heating control output |
| N Neutral | Y Cooling control output |
| N1 Room thermostat | |

Operating Diagrams

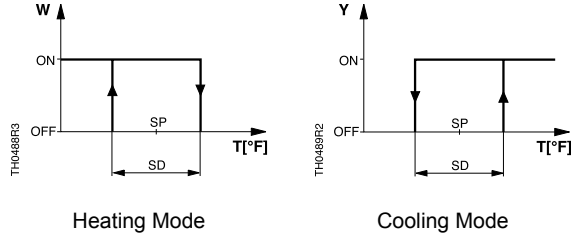

RAA10C.../RAA20U...

- | | |
|-------------------------------------|--------------------------------|
| Key | |
| T Room temperature | W Heating output signal |
| SD Switching differential | Y Cooling output signal |
| SP Room temperature setpoint | |